

TOPP VY
1:10

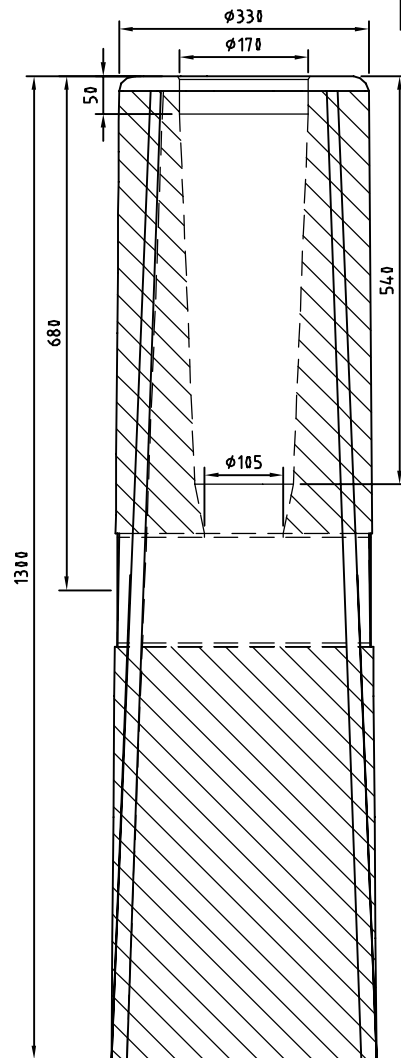

A-A
1:10

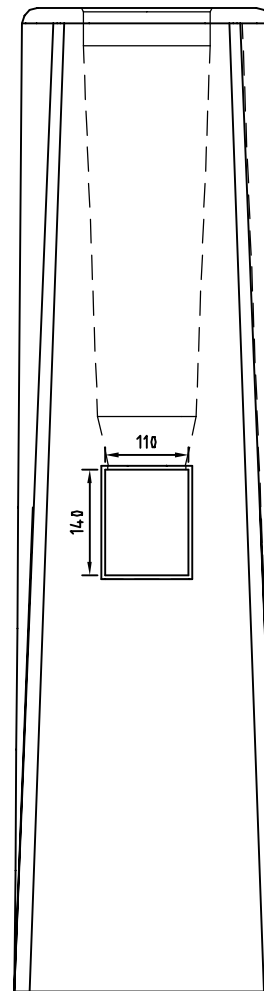

B-B
1:10

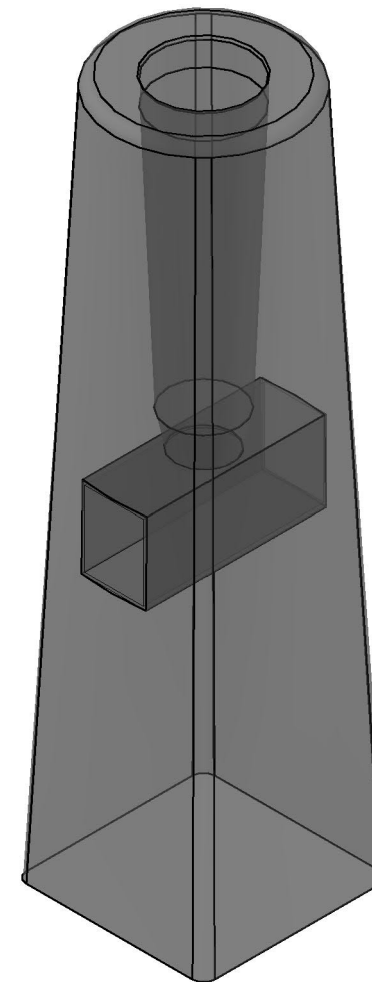

3D VY
1:10

		FUNDAMENT GRÖN 1300		DATUM 2019-01-31
		BETONGFUNDAMENT		ANSVARIG JA/PJ
		VIKT: 268 kg		SKALA 1:10
TELEFON 042-595 15	UPPDRAG	RITAD/KONSTRUERAD AV CGU	HANDLÄGGARE CGU	NUMMER 40030 BET